

HOUSING	OPERATING DISTANCE	MOUNTING	✓ One-piece housing in stainless steel V4A ✓ Robust and food-safe ✓ Corrosion resistant	✓ IP68 and IP69K, Ecolab ✓ Long operating distance ✓ Factor 1 on Fe and Al ✓ IO-Link v1.1
M12	10 mm	Non-embeddable		

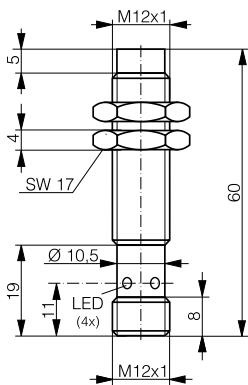

DW-LS-71x-M12

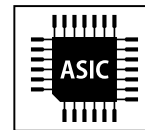
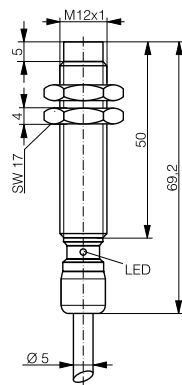

DW-LD-71x-M12

DETECTION DATA		INTERFACE	
Rated operating distance (S_n)	10 mm	Indicator LED, yellow	Sensing state ($0 \leq s \leq 0.8 S_r$)
Assured operating distance (S_a)	$\leq (0.81 \times S_n)$ mm	Indicator LED, yellow, blinking	Sensing state ($0.8 S_r < s \leq S_r$)
Repeat accuracy	≤ 0.3 mm	IO-Link	✓
Hysteresis	$3\% S_r < \text{Hyst} \leq 15\% S_r$	MTTF (@40°C)	1017 y
Temperature drift	$\leq 10\% S_r$		
Standard target	30 x 30 x 1 mm ³ , FE360		

Note: $0.9S_n \leq S_a \leq 1.1S_n$.

ELECTRICAL DATA		MECHANICAL DATA	
Supply voltage range (U_B)	10...30 VDC	Mounting	Non-embeddable
Residual ripple	$\leq 20\% U_B$	Housing material	V4A / 1.4435 / AISI 316L
Output current	≤ 200 mA	Sensing face material	V4A / 1.4435 / AISI 316L
Output voltage drop	≤ 2.0 VDC	Max tightening torque	20 Nm
Power consumption (no-load)	≤ 10 mA	Ambient operating temperature	-25...+85°C ¹
Residual current	≤ 0.1 mA	Enclosure rating	IP68 / IP69K
Switching frequency	≤ 400 Hz	Weight (cable/connector)	see page 2
Short-circuit protection	✓	Shock and vibration	IEC 60947-5-2 / 7.4
Voltage reversal protection	✓		
Cable length max.	≤ 300 m		

¹Maximum temperature according to UL: 70°C.

Note: all data measured according to IEC 60947-5-2 standard with $U_B=20 \dots 30$ VDC, $T_A=23^\circ\text{C} \pm 5^\circ\text{C}$.

CORRECTION FACTORS FOR TARGET OF

Steel FE 360	1	Copper	0.8	Aluminum	1	Brass	1.4	Stainless Steel V2A 1/2 mm	0.15 / 0.8
--------------	---	--------	-----	----------	---	-------	-----	----------------------------	------------

INSTALLATION CONDITIONS

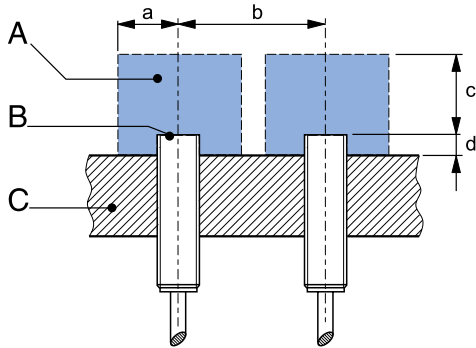

A : metal free zone a : 30 mm d : steel 21 mm
 B : sensing face b : 120 mm
 C : support c : 30 mm

IO-LINK FUNCTIONALITIES

IO-Link version	1.1
SIO mode	Supported
Process data	7-bit input
Baudrate	COM2 (38.4 kBaud)
Minimum cycle time	10.4 ms
ISDU	Not supported



IO-Link files may be downloaded from

www.contrinex.com/product-range/inductive-sensors/.

Select the product name to display the product page with corresponding downloads.

Alternatively, just click/scan the QR code on the left.

Note: additional installation information can be found in the glossary of the Contrinex General Catalog.

WIRING DIAGRAM

PIN ASSIGNMENT

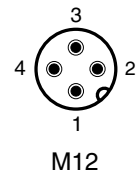
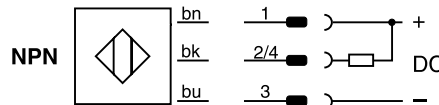
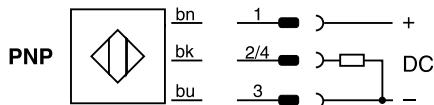

AVAILABLE TYPES

Part number	Part reference	Polarity	Connection	Output on pin 2	Output on pin 4 / bk	Weight
320-420-279	DW-LD-711-M12	NPN	TPE-S, 2 m, 3 wire	-	Normally open (NO)	83 g
320-420-280	DW-LD-712-M12	NPN	TPE-S, 2 m, 3 wire	Normally close (NC)	-	83 g
330-320-030	DW-LD-713-M12	PNP	TPE-S, 2 m, 3 wire	-	Normally open (NO) / IO-Link	83 g
320-420-282	DW-LD-714-M12	PNP	TPE-S, 2 m, 3 wire	Normally close (NC)	-	83 g
320-420-263	DW-LS-711-M12	NPN	M12 4-pin	-	Normally open (NO)	25 g
320-420-300	DW-LS-712-M12	NPN	M12 4-pin	Normally close (NC)	-	25 g
330-320-023	DW-LS-713-M12	PNP	M12 4-pin	-	Normally open (NO) / IO-Link	25 g
320-420-301	DW-LS-714-M12	PNP	M12 4-pin	Normally close (NC)	-	25 g

Note: part reference may include additional suffix to indicate a revision version or special version. Further information is available on request.

Operators of the products we supply are responsible for compliance with measures for the protection of persons. The use of our equipment in applications where the safety of persons might be at risk is only authorized if the operator observes and implements separate, appropriate and necessary measures for the protection of persons and machines. Terms of delivery and rights to change design reserved.